

OHIO MPQK Lottery Terminal Manual

October 2017



Document Policy

INTRALOT 2017. All rights reserved.

All copyright, intellectual and industrial rights in this document and in the technical knowledge it contains are owned by INTRALOT and/or their respective owners.

This document is made available to the end users only for their internal use.

No part of this document nor any data herein may be published, disclosed, copied, reproduced, redistributed by any form or means, electronically or mechanically, or used for any other purpose whatsoever without the prior written approval of INTRALOT.

Information as well as drawings and specifications contained in this document are subject to change without prior notice.

All trademarks and copyrights mentioned herein are the property of INTRALOT and/or their respective owners.

Any rights not expressly granted herein are reserved.

Declaration of Conformity

Hereby, INTRALOT declares that the MPQK lottery terminal is in compliance with the essential requirements and other relevant provisions of Directives:

1. Safety:
 - IEC60950-1:2005 + A1:2009 + A2:2013
 - UL 60950-1/R:2011-12
 - CAN/CSA-C22.2 No. 60950-1/A1:2011
2. Electromagnetic compatibility:
 - FCC Rules, Part 15, Subpart B, CFR 47

For further information, please visit <http://www.intralot.com>.

Note:

This equipment has been tested and found to comply with the limits for a Class A digital device, pursuant to part 15 of the FCC rules. These limits are designed to provide reasonable protection against harmful interference in a residential installation. This equipment generates uses and can radiate radio frequency energy and, if not installed and used in accordance with the instructions, may cause harmful interference to radio communications. However, there is no guarantee that interference will not occur in a particular installation. If this equipment does cause harmful interference to radio or television reception, which can be determined by turning the equipment off and on, the user is encouraged to try to correct the interference by one or more of the following measures:

- Reorient or relocate the receiving antenna
- Increase the separation between the equipment and receiver
- Connect the equipment into an outlet on a circuit different from that to which the receiver is connected
- Consult the dealer or an experienced radio/TV technician for help

MPQK Lottery Terminal Manual

Table of Contents

CHAPTER 1. TERMINAL OVERVIEW.....	4	CHAPTER 5. MACHINE SETTINGS MENUS.....	17
1.1. MPQK TERMINAL	4	5.1. DESCRIPTION	17
1.2. ELECTRICAL SAFETY WARNING	5	CHAPTER 6. DIAGNOSTICS MENU.....	18
1.3. ELECTROSTATIC DISCHARGE WARNING.....	5	6.1. DESCRIPTION	18
1.4. SAFETY INSTRUCTIONS	5	6.2. DIAGNOSTICS MENU BUTTONS	18
1.5. PRECAUTIONS FOR HANDLING.....	6	6.2.1. TEST DEVICES.....	19
1.6. THERMAL PRINTER.....	6	6.2.2. TEST DEVICES PARAMETERS	19
1.7. BILL VALIDATOR	6	6.3. DEVICE STATUS	20
1.8. CREDIT/DEBIT CARD READER	6	6.3.1. DEVICE STATUS SCREEN.....	20
1.9. TECHNICAL CHARACTERISTICS	7	CHAPTER 7. MISCELLANEOUS MENU.....	21
1.9.1. OPERATING CONDITIONS	7	7.1. DESCRIPTION	21
CHAPTER 2. BASIC OPERATIONS.....	8	7.2. MISCELLANEOUS MENU BUTTONS	21
2.1. ENTERING THE RETAILER MENU.....	8	7.3. REBOOT TERMINAL	21
2.1.1. NORMAL OPERATIONAL MODE.....	8	CHAPTER 8. TERMINAL BASIC OPERATIONS.....	22
2.1.2. MAINTENANCE MODE.....	9	8.1. POWER ON PROCEDURE.....	22
2.2. RETAIL MANAGER MAIN MENU	10	8.1.1. APPLYING POWER	22
CHAPTER 3. ACCOUNTING MENU.....	11	8.2. HOW TO PURCHASE OHIO LOTTERY GAMES	23
3.1. DESCRIPTION	11	8.2.1. CREDIT AND DEBIT CARDS.....	23
3.2. SERVER ACCOUNTING	11	8.2.2. CASH	27
3.3. SALES REPORTS	12	8.3. HOW TO PLAY QUICKENO GAMES	28
3.4. WEEKLY INVOICE REPORT	13	8.4. PURCHASING TRADITIONAL LOTTERY TICKETS	30
3.5. SHIFT REPORT	14	8.5. VOUCHER SYSTEM	30
3.5.1. RECONCILING CASH.....	14	8.6. CHECK A TICKET.....	34
3.6. PAY VOUCHER (CLEAR CR) REPORT / VOUCHER	14	8.8. BET CARD READER	34
3.6.1. PAY VOUCHER/CLEARING CUSTOMER CREDITS	14	8.9. REDEEMING TICKETS.....	35
CHAPTER 4. HISTORY MENU.....	15	CHAPTER 9. THERMAL PRINTER.....	36
4.1. DESCRIPTION	15	9.1. BASIC OPERATIONS	36
4.3. TICKETS HISTORY	16	9.1.1. LOADING A NEW PAPER ROLL	36
4.4. PRINT A PENDING TICKET.....	16		

Chapter 1. Terminal Overview

1.1. MPQK Terminal

MPQK terminal is a state of the art lottery terminal that allows the computerized sale of online games. MPQK consists of a metal enclosure of heavy construction (cabinet), which supports and protects the hardware and electronic units that are included. MPQK cabinet stands on a metal base which provides the terminal the ideal height, in order to be ergonomically correct for the players. The following figure presents the MPQK terminal:

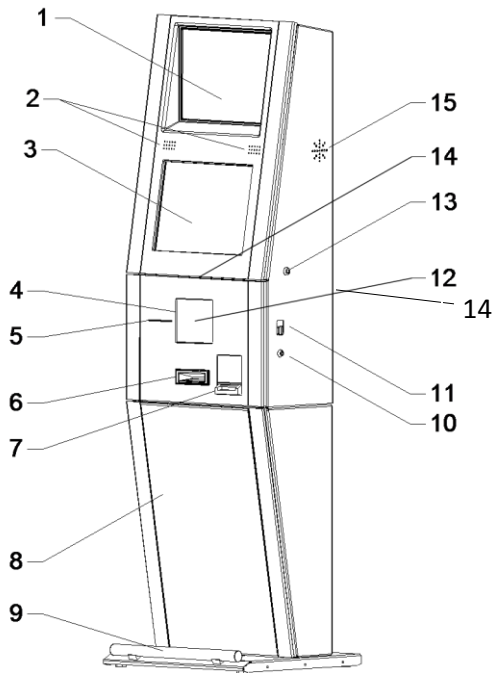

1. Top panel 19" TFT-LCD display
2. Main speakers
3. Main panel 19" TFT-LCD touch-screen display
4. Barcode reader gun area
5. Thermal printer output
6. Bet card reader input
7. Bill acceptor/validator slot
8. MPQK base
9. Footrest
10. Main door key lock
11. Main door handle
12. Card Reader
13. Maintenance Switch Lock
14. Arm Rest
15. Subwoofer Speaker

1.1. Safety Indications



Attention: Please read the safety warnings and the precautions provided in the following paragraphs, to ensure that you use your terminal safely. Do not attempt to use the terminal in any way not described in this manual.



Warning: Do not attempt to install, remove, re-cable, relocate the MPQK. Always call to have an Intralot technician perform these tasks on the equipment and the wiring.



Warning: Failure to follow these recommendations could result in serious injury to the personnel or damage to the terminal.

1.2. Electrical Safety Warning

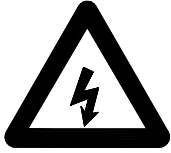

Follow all applicable national regulations when making power connections and grounding or mounting hardware.

Carefully examine the working area for possible hazards such as moist floors, ungrounded power extension cables and missing safety grounds.

Always keep the equipment and site area clean and free of dust.

The power cables must be disconnected before installing or moving the equipment.

1.3. Electrostatic Discharge Warning



Keep the equipment in the original packaging material and sheltered in the carton box until its installation.

It is always a good practice not to wear loose clothing, jewelry or other items that could get caught in the equipment.

Do not handle the equipment unnecessarily.

1.4. Safety Instructions

- The environment for use must be within the range specified in the environment specifications.
- Shut down the terminal immediately if it produces smoke, strange odor, or unusual noise. Unplug the terminal, open the hatch on the base and switch the UPS off. For additional safety unplug all AC outlets from the UPS and contact the Help Desk.
- When moving the MPQK terminal, make sure you carry either the cabinet or the base at both ends.



Warning: Always push the plug all the way into the power outlet. If the prongs of the power plug come into contact with metal objects, it may result on fire or electrical shock.



Attention: Never damage, modify, stretch or excessively bend or twist the power cord. Do not place heavy objects on the power cable. These actions may cause electrical damage and result in fire or electrical shock.

- Do not allow the power cable to be near objects that emit heat. The outer cover of the power cord may melt resulting in fire or electrical shock.
- Never use the terminal if the power cable is bundled or knotted. Knots in the cord may result in fire or electrical shock.

1.5. Precautions for Handling

To use the MPQK terminal safely, make sure to carefully examine the precautionary measures mentioned below, before you perform any operation to the terminal. CAUTION!!! Caution double pole/neutral fusing, disconnect plug of power cord from socket before service. Service should always be done by an Intralot technician. Do not pull the power cord of the terminal when it is in operation, unless in case of emergency. Avoid opening the MPQK main door, in the middle of game play.

1.6. Thermal Printer

- Use only paper rolls within the specification provided. For the printer use only paper rolls that are not glued to the core. The print quality or the life of the printer cannot be guaranteed if any other paper type is used other than what is recommended.
- Do not pull the paper without opening the platen.
- Do not apply excessive force to the cable connectors. Limit the number of times to attach and detach the connectors to 10 times.
- There are cases of discoloring of the printer paper if the printer is left unused for extended periods. If degradation of the printer paper or other damage occurs please replace with a new roll. It is recommended to install new printer paper because old or damaged thermal printer paper can cause improper printing or poor paper feeds. If a new roll is not available, you should discharge the part of the paper remaining for a long time in the paper feed path or damaged portion before using the printer. Replace with new roll when stock is received.
- The platen rubber may deform making printing thinner in some places, if the printer is left unused for extended periods.
- Initial print may be thin when using the printer in a cold environment because the thermal head is cold.
- When using the printer in a high temperature environment, the print may run or the characters may be distorted.
- Avoid sudden changes of the environment even if the ambient temperature and humidity are within standard.
- Do not use the printer in locations that are dusty, oily or exposed to metallic dust.

1.7. Bill Validator

- Avoid inserting torn, wrinkled or wet bills (banknotes) in the bill validator, because they may jam the device.
- Keep the terminal away from dust. Dust may deteriorate the accuracy of the bill acceptor.

1.8. Credit/Debit Card Reader

- The MPQK is now equipped with an Ingenico card reader. The card reader is going to allow players to use their debit or credit card to place funds on the machine. ANY funds placed on the machine using a debit or credit card must be played in full. A player will not be able to cash out (voucher out) any money that is placed on the machine using their card.

1.9. Technical Characteristics

1.9.1. Operating Conditions

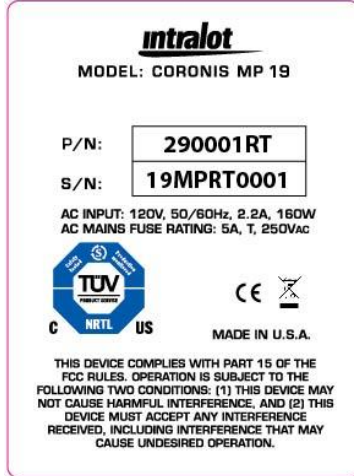

Always verify that the characteristics of the electric mains supply are suitable for the specifications indicated on the Identification plate of the MPQK terminal.

Environmental Conditions and Dimensions

The terminal should be placed in a suitable location to prevent defects, which may affect the electric and/or mechanical safety of the device. It must be protected from rain, humidity, saline or other environmental conditions that may influence the terminal's safety precautions.

The following table identifies the appropriate environmental conditions for the MPQK terminal.

Table 1. Environmental Conditions

Environmental Conditions	
Operating temperature	0°C to + 35°C
Storage temperature	-10°C to + 50°C
Permissible humidity	5% to 85% (non-condensing)

Table 2. Dimensions

Module	Dimensions (depth × width × height)	Weight
MPQK Cabinet	31.7 cm × 54.0 cm × 115.7 cm	154.3 lbs/70 kgr
MPQK Base	57.0 cm × 56.5 cm × 70.5 cm	286.6/130 kgr

Chapter 2. Basic Operations

2.1. Entering the Retailer Menu

2.1.1. Normal Operational Mode

When the terminal is in normal operation mode, a game or the game menu appears on the display.



QuickKeno™ Main Menu

2.1.2. Maintenance Mode

The maintenance mode of the IGS software opens to LT Maintenance with the Retail Clerk, Retail Manager and Admin menus, for auditing, controlling and configuring the terminal.

When entering the maintenance mode, the Maintenance menu appears on the display:



Maintenance Menu

Select the Retail Manager button. An onscreen keyboard appears and the Retail Manager password is required in order to gain access to the Retail Manager menu. Enter password and hit SUBMIT.

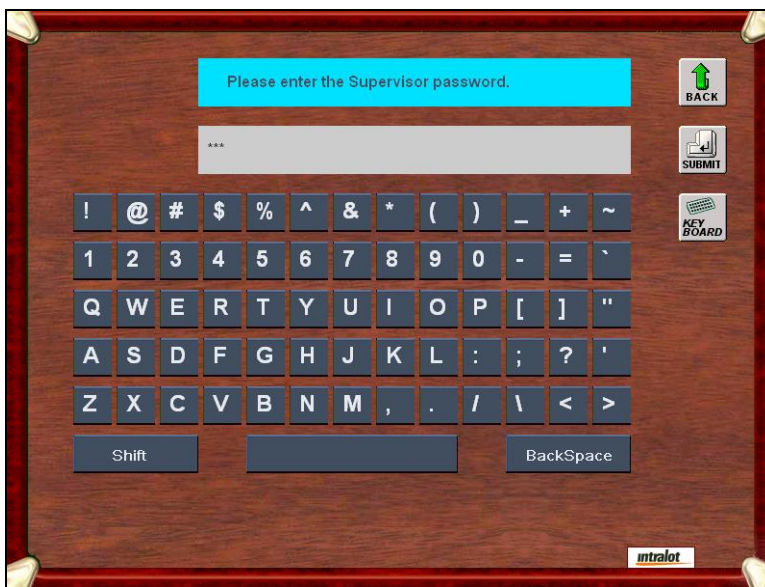

Retail Manager Password Screen

2.2. Retail Manager Main Menu

The Retail Manager main menu displays the following sub menus:

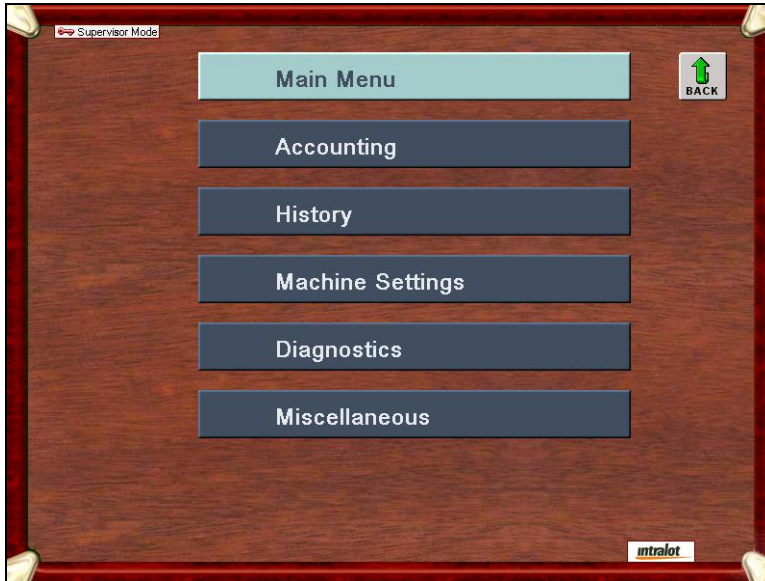

Retail Manager Main Menu

Accounting

- Sales Today
- Sales Yesterday
- Sales 2Days Past
- Sales 3Days Past
- Sales This Week
- Sales Last Week
- Sales 2Weeks Past
- Weekly Invoice
- Life Time Sales
- Configuration Reports
- Event Report
- Shift Report
- Pay Voucher (clear cr)
- Historical Shift Report

History

- Tickets History
- Bill Door
- Main Door
- CPU Door
- Coin Door
- Bills In

Machine Settings

- LT Settings

Diagnostics

- Test Devices
- Error Accounting
- View Device Status
- Security Event History

Miscellaneous

- Screen Test
- Reboot Terminal
- Shutdown Terminal
- Trigger Alarms
- Exit QuickKeno Games

Chapter 3. Accounting Menu

3.1. Description

The Accounting menu is displayed by selecting the Accounting button at the Retail Manager main menu.

3.2. Server Accounting

The Server Accounting screen displays:

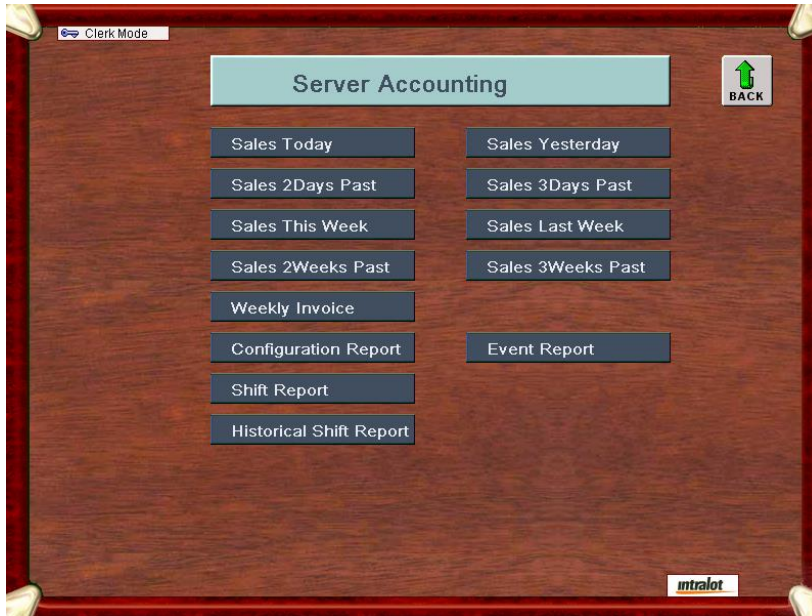

- Sales Today - Shows sales for the current day.
- Sales Yesterday - Shows sales for previous day.
- Sales 2Days Past – Shows sales for two days past.
- Sales 3Days Past – Shows sales for three days past.
- Sales This Week - Shows sales for the current week.
- Sales Last Week – Shows sale for the previous week.
- Sales 2Weeks Past – Shows sales for two weeks past.
- Sales 3Weeks Past – Shows sales for three weeks past.
- Weekly Invoice - Contains the current invoice for all online sales.
- Configuration – For use by service technicians.
- Event Report – Shows a list of “events” on the MP: door is opened; printer is out of paper, etc.
- Shift Report – Shows total sales, cashed tickets, cash collected, cleared credits since last closed shift report.
- Pay Voucher (clear cr) – Return credits balance to zero and creates a voucher for the player to redeem.
- Historical Shift Report – Ability to print previous shift reports.

Upon touching the PRINT button, the information displayed onscreen will be printed.

3.3. Sales Reports

The below image shows you data fields on the sales reports:

WWW.OHIO.LOTTERY.COM

www.ohiolottery.com



Mon, Apr 25, 2014 22:36:32

SALES SUMMARY - TODAY
06/07/16
Retailer: 1234501

EZPlay QuicKeno GAMES

EZPlay QuicKeno Game Sales	0.00
EZPlay QuicKeno Win Cashes	0.00
EZPlay QuicKeno Sales Comm	0.00

Total QuicKeno Net Amt Due 0.00

ONLINE

0 Gross Sales	0.00
0 Cancels	0.00
0 Cashes	0.00
0 Pay Voucher Cashes	0.00
0 Unplayed Money	0.00
0 Promo	0.00
0 Coupons	0.00
0 Adjustments	0.00

WWW.OHIO.LOTTERY.COM

Sales Comm	0.00
Cashing Comm	0.00
Cashing Bonus	0.00
0 Claim Bonus	0.00
Selling Bonus	0.00
Online Net Total	0.00
INSTANT	
0 Settlements	0.00
0 Returns	0.00
0 Cashes	0.00
0 Cashless QuicKeno Sales	0.00
0 Promos	0.00
0 Coupons	0.00
0 Adjustments	0.00
Sales Comm	0.00
Cashing Comm	0.00
Cashing Bonus	0.00
0 Claim Bonus	0.00
Selling Bonus	0.00
Instant Net Total	0.00
Balance	0.00

123456-12345 01 TR:00000000170

3.4.Weekly Invoice Report



AGENCY NO.: 00000001
 TERMINAL S/N: 00000000
 REPORT NO.: 5
 PRINTED....: 10/28/2017 13:45:12

Sun, Oct 28, 2017 13:45:12

 WEEKLY INVOICE
 10/22/17 - 10/28/17
 Retailer: 12345

WWW.OHIO.LOTTERY.COM

ONLINE NET DUE 924.64-
 INSTANT NET DUE 0.00
 TOTAL NET AMOUNT DUE 924.64-

EZPlay TAP GAMES
 EZPlay TAP Game Sales 81.00
 EZPlay TAP Win Cashes 4,301.48-
 EZPlay TAP Sales Comm 0.00
 Total EZPlay TAP Net Amt Due 4,220.48-

ONLINE GAMES
 Pick3 Sales 2,732.50
 Pick3 Cashes 50.00-
 Pick3 Cancels 0.00
 Pick4 Sales 1,132.00
 Pick4 Cashes 0.00
 Pick4 Cancels 0.00
 Pick5 Sales 168.50
 Pick5 Cashes 0.00
 Pick5 Cancels 0.00
 Rolling Cash 5 Sales 5,800.00
 Rolling Cash 5 Cashes 0.00
 Rolling Cash 5 Cancels 0.00
 Lucky For Life Sales 0.00
 Lucky For Life Cashes 0.00
 Classic Lotto Sales 6,050.00
 Classic Lotto Cashes 0.00
 Classic Lotto Cancels 0.00
 Mega Mill/Megaplier Sales 6.00
 Mega Mill/Megaplier Cashes 0.00
 EZPLAY Sales 0.00
 EZPLAY Cashes 0.00
 EZPLAY QuicKeno Sales 0.00
 EZPLAY QuicKeno Win Cashes 0.00
 RAFFLE Sales 0.00
 RAFFLE Cashes 0.00

WWW.OHIO.LOTTERY.COM

Powerball/Power Play Sales 0.00
 Powerball/Power Play Cashes 0.00
 CLASSIC KICKER™ Sales 550.00
 CLASSIC KICKER™ Cashes 0.00
 CLASSIC KICKER™ Cancels 0.00
 Multi State RAFFLE Sales 0.00
 Multi State RAFFLE Cashes 0.00
 Keno/Booster Sales 0.00
 Keno/Booster Cashes 0.00
 Keno/Booster Cancels 0.00
 Ohio 50/50 Sales 0.00
 Ohio 50/50 Cashes 0.00
 Ten-OH! Sales 0.00
 Ten-OH! Cashes 0.00
 Ten-OH! Cancels 0.00

Gross Sales 16,438.00
 Cancels 0.00
 Net Sales 16,439.00

Pay Voucher Cashes 13,330.57-
 Cashless Online Sales 100.00-
 Unplayed Money 1,269.05
 Cashes 50.00-
 Promos 0.00
 Coupons 0.00
 Adjustments 9.00-
 Sales Comm 904.14-
 Cashing Comm 0.50-
 Cashing Bonus 0.00
 Claim Bonus 20.00-
 Selling Bonus 0.00
 Quarterly Bonus 10.00-
 Communications Charge 12.00
 License Fee 0.00

Online Net Due 924.64-

INSTANT
 Sales Settlements 0.00
 Returns 0.00
 Low Tier Cashes 0.00
 Mid Tier Cashes 0.00
 Cashless Instant Sales 0.00
 Promos 0.00
 Coupons 0.00
 Adjustments 0.00
 Sales Comm 0.00
 Cashing Comm 0.00
 Cashing Bonus 0.00
 Claim Bonus 0.00
 Selling Bonus 0.00

Instant Net Due 0.00

123456-12345 01 TR:00000000170

3.5. Shift Report



3.5.1. Reconciling Cash

This function allows the retailer to view current shift and start a new shift/reporting period:

To view current shift press PRINT.

To close current shift, press CLEAR. Select YES for cash collected. The shift report will print. Make sure to collect the cash. Cash denominations reported will reflect the currency in the cash box. Cash should equal total cash not total sales. This is how the counters are zeroed out to begin the new shift/reporting period.

3.6. Pay Voucher (Clear Cr) Report / Voucher



3.6.1. Pay Voucher/Clearing Customer Credits

The Pay Voucher (clear cr) report allows a retailer to refund the customers cash without removing the cash box, clear credits on the machine and produces a voucher that the player can redeem later for cash.

Press Pay Voucher (clear cr) and a confirmation screen will appear. Select YES to continue. Credits will be returned to zero and a receipt will print showing the value.

Chapter 4. History Menu

4.1. Description

The History menu is displayed by selecting the History button at the Retail Manager main menu.

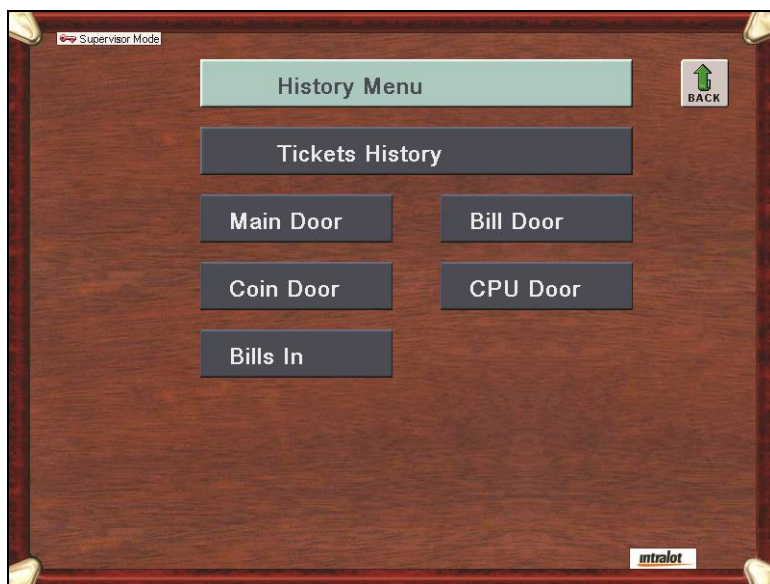

4.2. History Menu Buttons

Button	Description
Tickets History	Displays information about the payments. The payments appear in “most recent first” order. The last voucher ticket appears first in the list.
Main Door	Displays information about the status of the main door.
Bill Door	Displays information about the status of the bill door.
Coin Door	Displays information about the status of the coin door. (Not used in the U.S.)
CPU Door	The CPU Door History screen displays information about the status of the CPU door of the terminal. It also displays the date and the time that each event took place.
Bills In	The Bills History screen displays information about the legal paper money inserted in the bill acceptor. The screen displays the date, the time and the denomination of the bills inserted.

4.3. Tickets History

The Tickets History screen provides critical information regarding each game played. It is also where you can print a ticket that may not have printed for some reason and is in the MPQK print queue.

The Tickets History screen displays:



4.4. Print a Pending Ticket

- From main menu choose History, and then press Ticket History. You will then see the above screen with a list of tickets. You can only print a pending ticket if it actually exists in the queue.
- Select the pending ticket by touching it on the list, it will highlight when you press it, then press the Re-Print button to print the pending ticket. If you select the Print button, it will give you a list of the ticket history that you see on the screen and not the pending ticket.

Chapter 5. Machine Settings Menus

5.1. Description

The Machine Settings menu is displayed by selecting the Machine Settings button at the Retail Manager main menu. This is where you can change your Retail Manager and Retail Clerk passwords.

Choose either Retail Clerk or Retail Manager depending on which you want to change by pressing the Edit button next to the corresponding feature. A keypad will display for you to change the password.

Press LT Settings

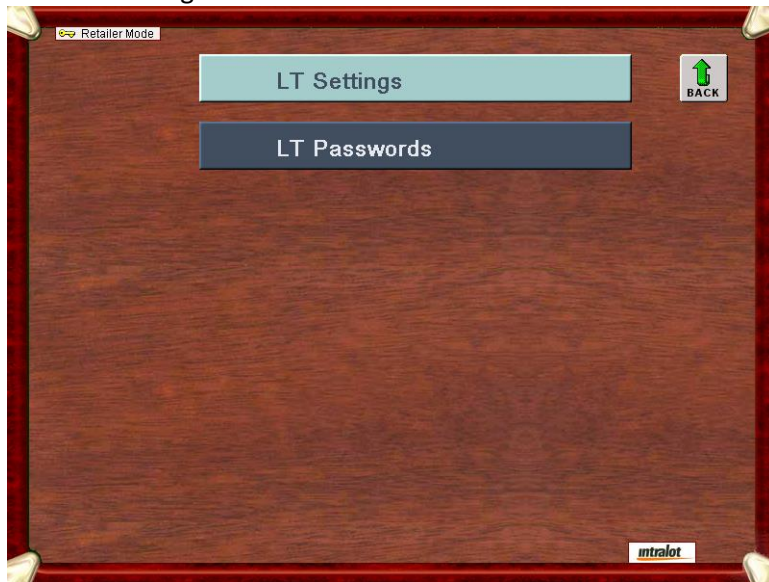

Press LT Passwords



****Keep in mind that if you forget the password a technician will have to be dispatched to reset.****

Chapter 6. Diagnostics Menu

6.1. Description

The Diagnostics menu is displayed by selecting Diagnostics at the Retail Manager main menu.

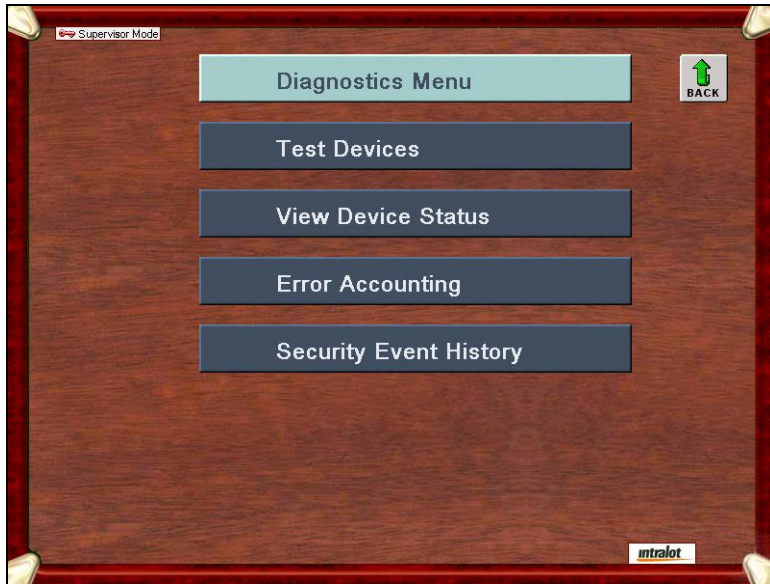

6.2. Diagnostics Menu Buttons

Button	Description
Test Devices	Allows the retailer to test the functionality of the terminal devices.
View Device Status	Displays the status of the terminal peripheral devices.
Error Accounting	Displays the hardware errors that occur to the terminal, etc. This function is accessed when the hotline is trouble shooting.
Security Event History	Displays a list with the events that occurred to the terminal. The last event appears first in the list.

6.2.1. Test Devices

The Test Devices screen displays:

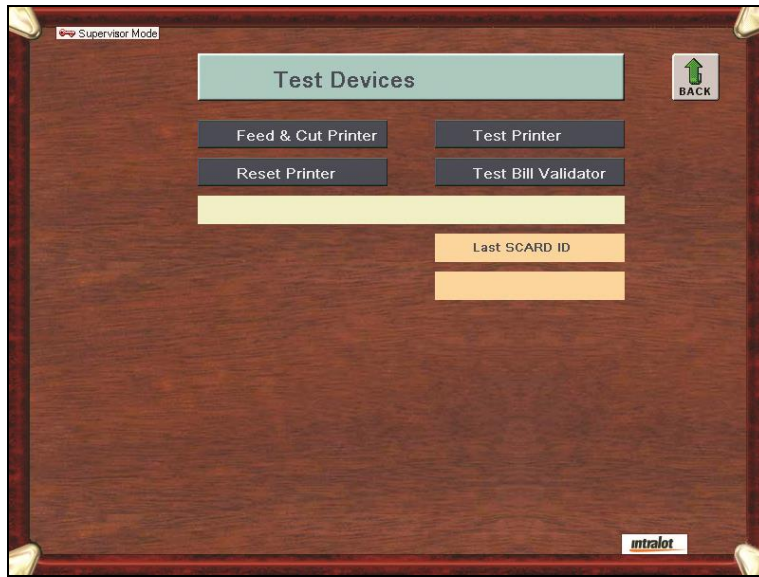

The test devices option allows the supervisor to dynamically perform several hardware tests to the terminal peripheral devices.

6.2.2. Test Devices Parameters

Button	Description
Feed & Cut Printer	Tests the printer by forcing the device to perform a feed and cut.
Reset Printer	Re-initializes the printer.
Test Printer	Prints a test printer voucher.
Test Bill Validator	Re-initializes the bill validator.
Last SCARD ID	Displays dynamically the ID of the currently inserted SCARD.

6.3. Device Status

The Device Status screen displays:



6.3.1. Device Status Screen

The screen takes a “picture” of the terminal and displays the status of its devices. The device rows present the status codes of the hardware devices and its equivalent processes. The last four devices listed indicate if a door is open or closed.

A GREEN (■) box will indicate the device is working properly.

A RED (■) box will indicate there is a problem with the device.

A LIGHT TURQUOISE (■) box will be displayed if the door is open.

A DARK TURQUOISE (■) box will be displayed if the door is closed.

** Please note that the SCard Reader is not used and will display the message “SCard Reader Not Configured” Also the PDC device is not used and will display the message “PDC device not present”.

Chapter 7. Miscellaneous Menu

7.1. Description

The Miscellaneous menu is displayed by selecting Miscellaneous at the Retail Manager main



7.2. Miscellaneous Menu Buttons

Button	Description
Screen Test	Enables the floor personnel to test the screen of the terminal.
Shutdown Terminal	Enables the floor personnel to shut down the terminal.
Reboot Terminal	Allows the floor personnel to reboot the terminal.
Trigger Alarms	Allows retailer to inform the central system that a peripheral is malfunctioning.
Exit QuickKeno Games	This is used if a QUICKENO game is frozen/not displaying. After pressing this button and turning the key back to play mode, it will return to the Main Online Ticket screen. It will also have a confirmation screen.

7.3. Reboot Terminal

The following message appears on the display:

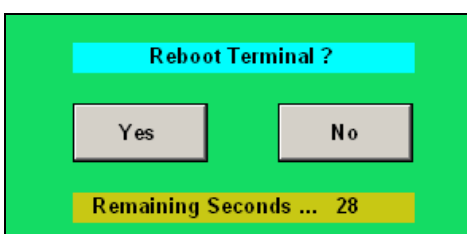

Select Yes to process or No to cancel the action.

Chapter 8. Terminal Basic Operations

8.1. Power On Procedure

8.1.1. Applying Power

Upon the application of power to the MPQK terminal the following Checking Peripherals screen appears:

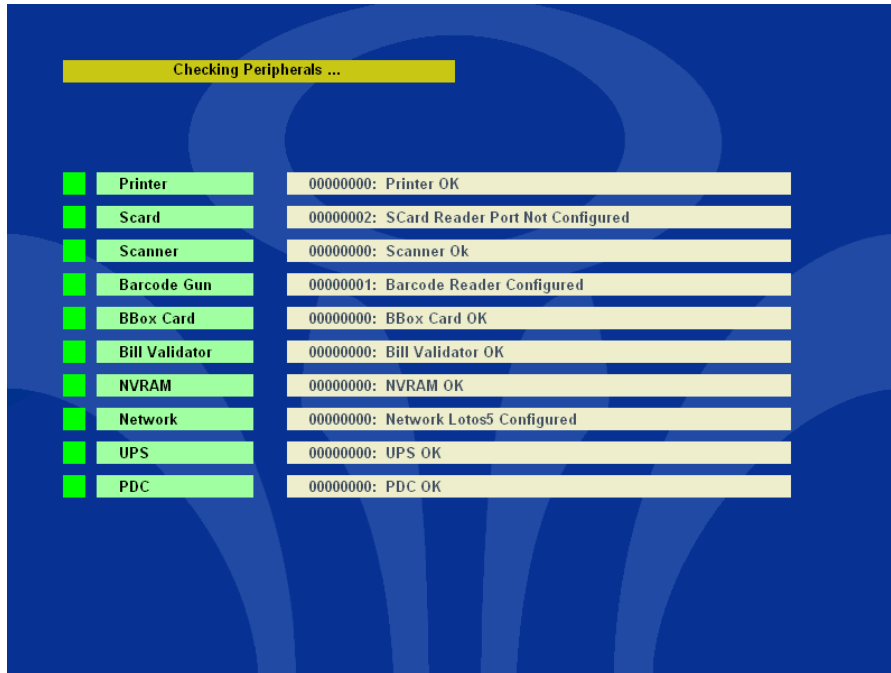

If a test fails, an appropriate message is displayed to show where the error occurred.

8.2. How to Purchase Ohio Lottery Games

8.2.1. Credit and Debit Cards

The MPQK is now equipped with an Ingenico card reader. The card reader is going to allow players to use their debit or credit card to place funds on the machine. ANY funds placed on the machine using a debit or credit card must be played in full. A player will not be able to cash out (voucher out) any money that is placed on the machine using their card.

Visa, Mastercard and Discover cards are accepted.

The following steps will show what the card reader will display when being used:

1. Select amount will appear when the PIN pad is working. A player is prompted to select which amount they wish to put on the terminal:



- a. If the system is down, the PIN pad will read "OUT OF SERVICE"



2. Please Wait will appear.



3. The player is then instructed to Insert or Swipe Credit Card

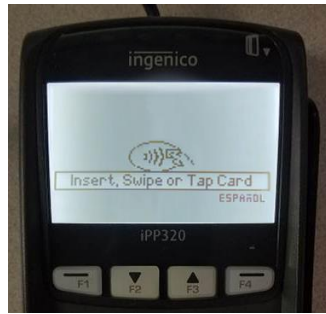

4. If card has a preferred language, it will ask "Select Language".



5. If preferred language is English, no question is asked and "Please Wait, Do Not Remove Card" is shown"



6. After amount is selected and language is confirmed. It will confirm “Amount Ok \$XX.XX?”

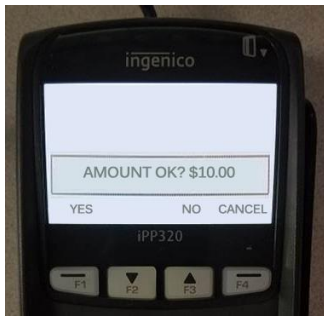

a. If No is selected, the below message will appear



b. Then this message will appear:



c. If “Cancel” is selected the message below will show:



d. Then this message will appear:

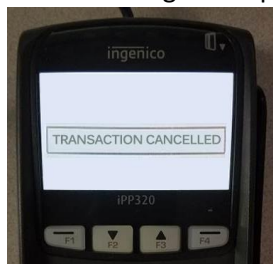

7. When “Yes” is selected the following message will appear:



8. After the PIN is entered in, and accepted the message “PIN OK” appears



9. After the PIN is accepted, the system begins to process and sends the following message:



10. Once processing completes and the transaction is approved, the message “APPROVED PLEASE REMOVE CARD” appears:



- a. If processing completes, but the card exceeds amount used, the error message “002: EXCEEDS AMOUNT PLEASE REMOVE CARD” will appear:



- b. If processing completes, but the card is declined, the error message “Transaction Declined” will appear:



8.2.2. Cash

Place the exact amount of the money you wish to play in the bill acceptor. The amount of money played appears in the lower middle section of the screen in the balance window. See screen below.

The bill acceptor accepts \$1, \$5, \$10, \$20, \$50, and \$100 bills, which can be inserted in any direction, either side up. The pre-defined cash in limit is \$200. Thus, if a bill inserted exceeds the maximum balance it is automatically rejected.

8.3. How to Play QuickKeno Games



The player will select which game they wish to play from the game lobby. They will enter that game and see the main game screen for the selected game (see example below).

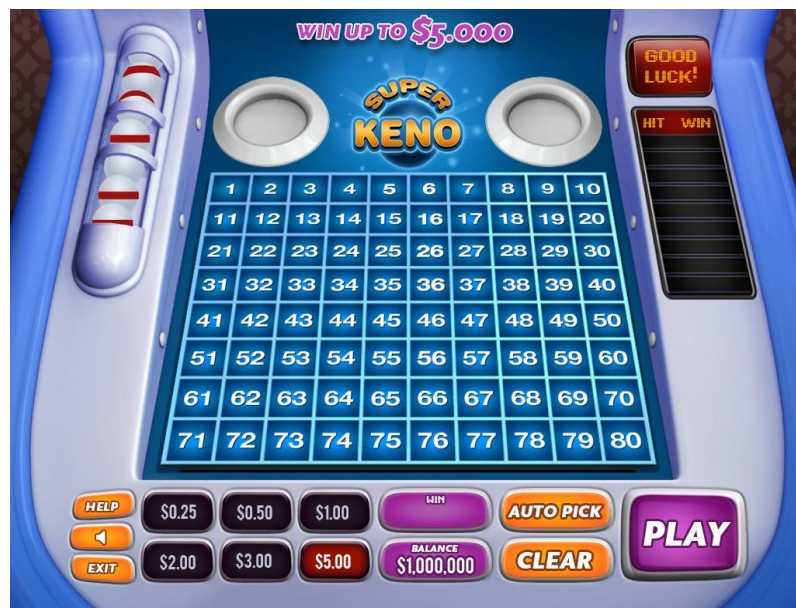

For each game:

1. Player will select wager amount
2. Player will select any interactive game option or game setting
3. Player will activate game by pressing PLAY (or other button indicated to start game, i.e. Shake)
4. Once the player activates the game the play or ticket wager amount is deducted from the terminal balance. Any winnings will appear in a designated winning area and will immediately transfer to the balance of the terminal.

Note: All games will have a help screen with a how to play/how to win, odds and prizes table (see example below).



\$5.00

Spots Marked

Match	1	2	3	4	5	6	7	8	9	10
1		\$5.00								
2		\$30.00	\$10.00	\$5.00	\$5.00					
3			\$60.00	\$30.00	\$10.00	\$10.00	\$5.00	\$5.00		
4				\$250.00	\$50.00	\$35.00	\$20.00	\$10.00	\$10.00	\$5.00
5					\$500.00	\$155.00	\$70.00	\$30.00	\$20.00	\$20.00
6						\$750.00	\$300.00	\$105.00	\$80.00	\$40.00
7							\$1,000.00	\$500.00	\$450.00	\$125.00
8								\$2,500.00	\$1,000.00	\$625.00
9									\$5,000.00	\$2,500.00
10										\$5,000.00

\$0.25

\$0.50

\$1.00

\$2.00

\$3.00

\$5.00

HOW TO PLAY AND WIN SUPER KENO

Super Keno is an exciting and simple game to play. The aim of the game is to predict which numbers you think will be "called" once you press "PLAY". You can select between 2 to 10 numbers per round. The more numbers you play, the more you can win!

1. Choose your wager amount from one of the 6 bet buttons
2. Select your lucky numbers (Min 2 / Max 10)
3. Press "PLAY"
4. Wait for all the balls to fall into place

Winning Conditions:
Every ball that lands on one of your selected numbers is a winner. The more winning numbers you have, the bigger your prize. You can see your winning potential per correct number under the "PAYTABLE" on the right hand side.

Game Play Tips:
** Use "AUTO PICK" and 10 numbers will be automatically selected for you, then simply hit "PLAY"
 * The "WIN UP TO..." at the top of the game indicates the highest potential prize you can win based on your bet size and the amount of numbers you have selected.*

EXIT

Ohio Problem
Gambling Helpline
1-800-589-9966

ohio.gov 



© Intralot Inc. MPQK Terminal Manual – October 2017

Page 29

8.4. Purchasing Traditional Lottery Tickets

The player has the ability to purchase all traditional lottery products by selecting the Buy Traditional Ohio Lottery products button. Games are grouped by container buttons. Touch the container icon of the game you wish to play. After 15 seconds of inactivity the screen will default back to the main QuickKeno game menu.



8.5. Voucher System

The voucher system will allow players to transfer funds across the entire retailer base by using the MP, MPQK, microLOT and HEE terminals. The TVM will not be enabled to support pay vouchers.

The Cash Out Balance button will allow the player to cash out their current credit balance on the MPQK to a pay voucher. Vouchers are valid for 180 days from the day printed.



When the Cash Out Balance button is pressed the Cash Out keypad will be displayed.



The Cash Out keypad will default to display the minimum amount that the player must cash out. The default minimum amount that the player can cash out is \$1.00. If the full balance amount is greater than \$599.99, the amount field will default to \$1.00 unless the full balance amount, minus \$599.99, is greater than \$1.00. In that case, it will default to the full balance amount minus \$599.99. The amount field on the Cash Out keypad will be populated from right to left with the numbers. The decimal point field will be populated first.

- **Cash All button** – if the player selects the Cash All button, the amount field will be populated with the total balance on the machine as long as the total balance is less than \$599.99. If the total balance is greater than \$599.99, the Cash All button will update the amount field to \$599.99.
- **Clear AMT button** – if the player selects the Clear AMT button the amount field will be cleared.
- **OK button** – if the player selects the OK button, a pay voucher is produced for the amount selected.
- **Back button** – if the player selects the Back button, the player will be returned to the screen they were on prior to selecting the Cash Out Balance button. The balance remains unchanged on the MP when the Back button is selected.

If the player specifies an amount less than their balance, a pay voucher will be printed and the remaining balance will allow them to continue to play. If the amount specified by the player is equal to their balance, then a voucher is produced and the session is closed.

- If the amount specified by the player is greater than their balance, the calculator will automatically change the amount to the balance amount, unless the full balance amount is greater than \$599.99. If the full balance amount is greater than \$599.99, the amount field will display \$599.99.
- If the player balance is greater than \$599.99, and the amount specified by the player is greater than \$599.99, the calculator will automatically change the amount to \$599.99.
- The minimum cash out amount allowed on the Cash Out keypad will be \$1.00, unless the player balance is less than \$1.00. If the player balance is less than \$1.00, the Cash Out keypad will default to the player balance and will not allow the player to change the amount. If the player balance is greater than \$1.00 and the player attempts to specify an amount less than \$1.00, the calculator will automatically change to \$1.00.

Examples:

- **Player balance = \$.80**
 - **Default cash out amount = \$.80**
 - **Minimum cash out amount = \$.80**
 - **Maximum cash out amount = \$.80**
- **Player balance = \$75.00**
 - **Default cash out amount = \$1.00**
 - **Minimum cash out amount = \$1.00**
 - **Maximum cash out amount = \$75.00**
- **Player balance = \$680.00**
 - **Default cash out amount = \$80.01**
 - **Minimum cash out amount = \$80.01**
 - **Maximum cash out amount = \$599.99**
- **Player balance = \$1199.98**
 - **Default cash out amount = \$599.99**
 - **Minimum cash out amount = \$599.99**
 - **Maximum cash out amount = \$599.99**
- **Maximum player balance on the machine is \$1199.98**
 - **Player has a balance of \$599.99 and wins \$599.99**

If a prize higher than \$599.99 is won, that single prize will automatically print on a voucher and the players balance will remain on the machine. The below congratulations message will appear.

Congratulations on your winning ticket!

The amount of this individual winning ticket/play is higher than \$599.99 and requires a separate voucher to be printed.

Your existing balance amount will remain on the terminal
Please wait for your winning voucher to be dispensed. See
Retail Clerk for information about cashing this voucher.

Tap anywhere on the screen to continue.

If a prize lower than \$599.99 is won, but that single prize has put the terminal balance over \$599.99. The following messages will appear to alert the player that they must cash out at least a partial balance.

Notification that winnings have exceeded balance limit:

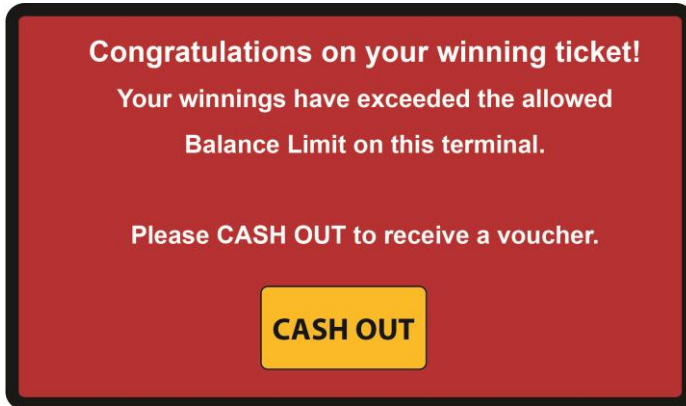

Calculator is presented for player to cash out; all or partial:



Second notification message, If player attempts press play after cancelling out of the CASH OUT message:

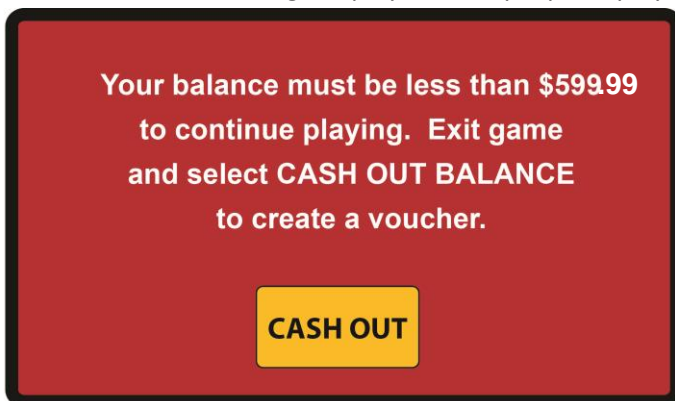

8.6. Check a Ticket

With the MPQK's integrated "Check-Your-Ticket" barcode reader, players may check and validate online tickets, instant tickets and pay vouchers, as long as the MPQK is connected to the central system.

To check for winning tickets, simply place the bottom barcode of an online ticket, instant ticket or pay voucher under the barcode reader so that the barcode is picked up by the reader. With the motion sensor technology integrated in the barcode reader, each ticket is automatically detected and scanned instantly.

Winning tickets can be credited to the MPQK's balance; the maximum winning amount allowed to be credited is \$599. Thus, if this amount is not exceeded, then instead of claiming the winnings (cash) from the retailer, the player can choose to purchase additional tickets up to the remaining balance. In this case, the winning ticket, when checked, will show a pop-up verification screen on the MPQK to ask if the player wants to use the winnings as a credit on the machine. If so, press Yes, and No if they would prefer to cash at a retailer location.

Note: When a ticket is "validated" or used for credit on the MPQK, it cannot be cashed again.

If, after a pre-configured number of seconds, the winning ticket is not scanned for a second time, the MPQK returns to the previous screen.

8.7. Play It Again/QR Code

The Play it Again barcode/QR Code located at the top of on-line tickets can be used to repeat the player's original wager (numbers, bet amount, bet type) for the next available draw or to produce another game ticket.

If the top of the ticket is placed under the scanner, the terminal will read the PIA barcode/QR Code and a pop up screen will ask the following: "The ticket you scanned costs \$x.xx. Do you wish to play it again?" The screen will have a Yes and No button for the player to make their choice. Choosing Yes will produce the ticket and subtract the wager amount from the player's balance. Choosing No will exit out of the pop-up screen, or it will automatically exit after 10 seconds if no button is chosen.

If the PIA barcode is on a Pick3 or Pick4 ticket, a ticket will print with the same numbers, bet amount and bet type.

For example, if the Pick3/4 ticket to replay reads "Midday Only", the replayed ticket will be for the next available Midday draw. Similarly, for "Evening Only".

8.8. Bet Card Reader

To scan a bet card simply insert it face up in the bet card reader. If an error occurs while reading a bet card, on-screen instructions advise the player to correct the bet card and retry, mark the panel void or choose another product.

8.9. Redeeming Tickets

If a ticket has won and the prize won is under \$599.99, then it is possible to redeem the ticket in order to play this amount of money again.

1. Scan the winning ticket under the barcode reader. If it wins the following message appears on the screen:

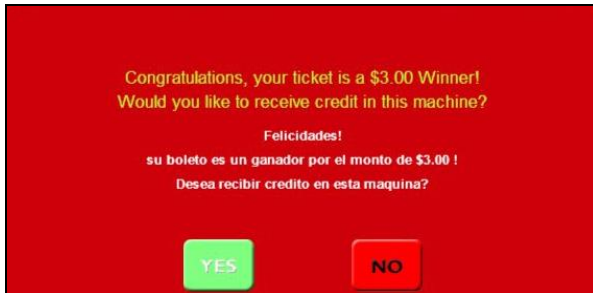

2. By pressing **YES**, the amount of money appears on the screen.

Note: If there is more than one draw, an **EXCHANGE TICKET** is printed out which informs the player of the remaining draws.

If the ticket has been previously paid, the following screen appears on the terminal:

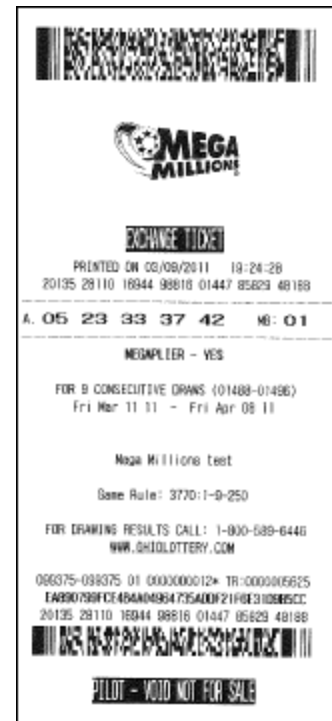
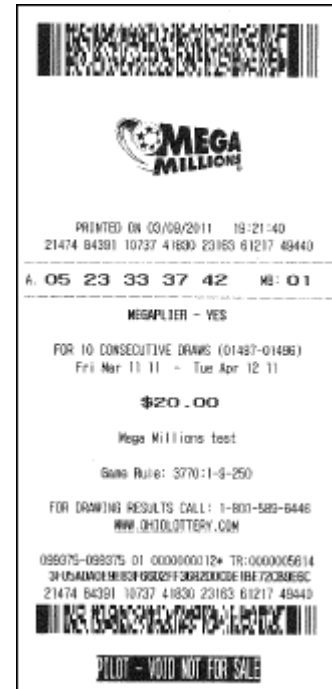

Chapter 9. Thermal Printer

9.1. Basic Operations

9.1.1. Loading a New Paper Roll

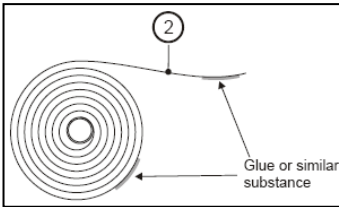
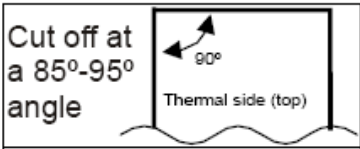
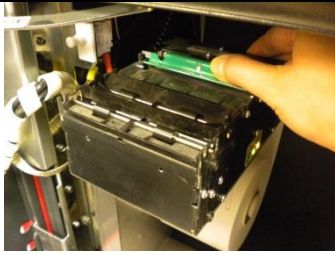
Step	Action
1	Unlock the main door and locate the printer on left side of interior.
2	The paper roll should feed from bottom up as shown. Load the paper onto the spindle with the end under the roll towards the back and over the top to point forward with the thermal side on top. 
3	Tear off a full turn of the from the new paper roll. Cut the paper straight across.   <p style="text-align: right;">paper</p>
	Note: This is important since the outer end of the paper is usually fixed to the roll with some type of glue or self-adhesive substance that might otherwise cause paper jam or even print head damage.
4	Push backward the paper cutter/holder (green bar) and lift up. 
5	Feed the paper through the opening at the back of the printer and under the paper cutter/holder (green bar), then press down evenly making sure both corners click closed. The printer will now feed, cut and eject a piece of paper around 4 3/4 inches long. This means the paper is loaded properly. If not, please reload paper.
6	MPQK is ready to operate.

13500 Darice Parkway, Suite C, Strongsville, OH 44149

(T) 440-268-2898 (F) 440-238-3826

Intralot hotline - 1-866-710-2462
www.intralot.com